



# SmartyCam 3 GP

On-board camera



SMARTYCAM 3 GP  
MODULE

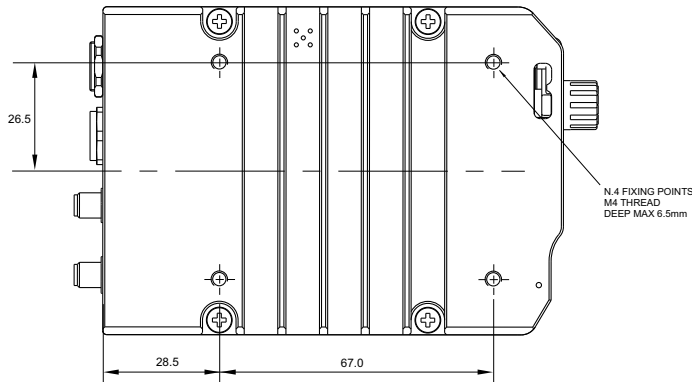

SMARTYCAM 3 GP  
BULLET CAM 120°

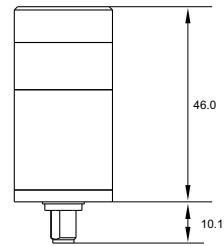

SMARTYCAM 3 GP  
BULLET CAM 67°- 84°

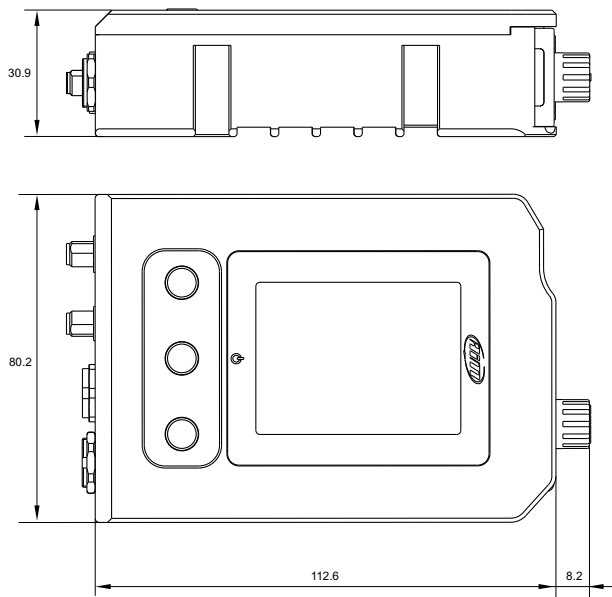
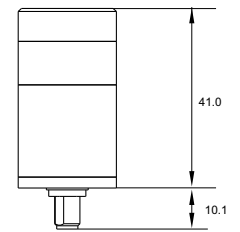



# SmartyCam 3 GP

On-board camera

## Pinout

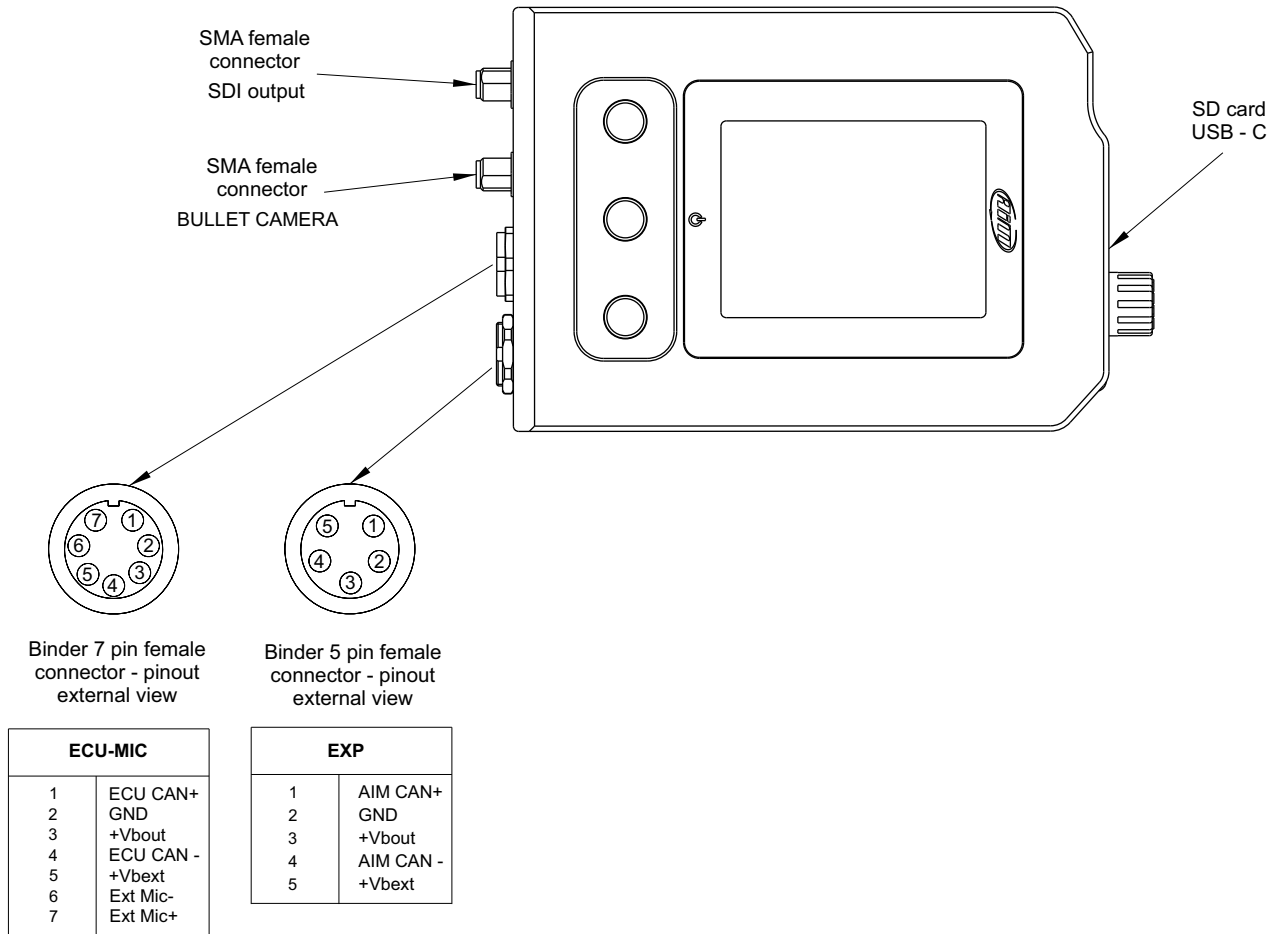



# SmartyCam 3 GP

On-board camera

## Technical characteristics

<b>Video format</b>	H.264 1920 x 1080 pixels @ 60 fps
<b>Display resolution</b>	2.4" 240 x 320 pixels
<b>Lens</b>	Low distortion camera lens
<b>CMOS sensor</b>	Global Shutter
<b>Field of view</b>	67°, 84° or 120°
<b>Internal battery</b>	Rechargeable lithium battery
<b>Video Out</b>	3G-SDI
<b>External power</b>	9-15 Volt
<b>Supported SD card</b>	Up to 2 TB
<b>Usage temperatures</b>	-10°C/+50°C
<b>Auto Power ON</b>	Yes
<b>Auto Power OFF</b>	Yes
<b>Auto Start/Stop Recording</b>	Yes
<b>Body</b>	Anodized Aluminum
<b>Dimensions</b>	Main unit 120.8 x 80.2 x 30.9 mm Bullet camera 24 diam x 46.0 mm (120° lens) Bullet camera 24 diam x 41.0 mm (67°-84° lens)
<b>Connectors</b>	2 Binder 712 female connectors + 2 SMA female connector (see pinout page) + 1 USB-C
<b>Bullet cable length</b>	From 0.5 m to 4 m (7 lengths available)
<b>Weight</b>	Main unit 320 g Bullet 45 g
<b>Waterproof</b>	IP65









# SmartyCam 3 GP







On-board camera

## Kits, accessories & spare parts







### Kit 1 SmartyCam 3 GP 67° lens CAN 2 m

Description	Part number*	The kit contains					
SmartyCam 3 GP Kit with bullet cam 67° + CAN Exp. cable 2 m	<b>XS3GPFHD067L200</b> □	SmartyCam 3 GP Module	Bullet cam 67°	Battery charger with AC adapter	Bullet cam cable 2 m	CAN Expansion cable 2 m	USB 2.0 Type A cable
							







### Kit 2 SmartyCam 3 GP 67° lens CAN 4 m

Description	Part number*	The kit contains					
SmartyCam 3 GP Kit with bullet cam 67° + CAN Exp. cable 4 m	<b>XS3GPHFD067L201</b> □	SmartyCam 3 GP Module	Bullet cam 67°	Battery charger with AC adapter	Bullet cam cable 2 m	CAN Expansion cable 4 m	USB 2.0 Type A cable
							

### Kit 3 SmartyCam 3 GP 84° lens CAN 2 m

Description	Part number*	The kit contains					
SmartyCam 3 GP Kit with bullet cam 84° + CAN Exp. cable 2 m	<b>XS3GPFHD084L200</b> □	SmartyCam 3 GP Module	Bullet cam 84°	Battery charger with AC adapter	Bullet cam cable 2 m	CAN Expansion cable 2 m	USB 2.0 Type A cable
							

### Kit 4 SmartyCam 3 GP 84° lens CAN 4 m

Description	Part number*	The kit contains					
SmartyCam 3 GP Kit with bullet cam 84° + CAN Exp. cable 4 m	<b>XS3GPHFD084L201</b> □	SmartyCam 3 GP Module	Bullet cam 84°	Battery charger with AC adapter	Bullet cam cable 2 m	CAN Expansion cable 4 m	USB 2.0 Type A cable
							

\* AC Adapter: substitute □ with:

- E** for Europe
- G** for UK
- U** for USA
- A** for Australia









# SmartyCam 3 GP







On-board camera

## Kits, accessories & spare parts

### Kit 5 SmartyCam 3 GP 120° lens CAN 2 m

Description	Part number*	The kit contains					
SmartyCam 3 GP Kit with bullet cam 120° + CAN Exp. cable 2 m	<b>XS3GPFHD120L200</b> □	SmartyCam 3 GP Module	Bullet cam 120°	Battery charger with AC adapter	Bullet cam cable 2 m	CAN Expansion cable 2 m	USB 2.0 Type A cable
							



### Kit 6 SmartyCam 3 GP 120° lens CAN 4 m

Description	Part number*	The kit contains					
SmartyCam 3 GP Kit with bullet cam 120° + CAN Exp. cable 4 m	<b>XS3GPHFD120L201</b> □	SmartyCam 3 GP Module	Bullet cam 120°	Battery charger with AC adapter	Bullet cam cable 2 m	CAN Expansion cable 4 m	USB 2.0 Type A cable
							

\* AC Adapter: substitute □ with:

- E** for Europe
- G** for UK
- U** for USA
- A** for Australia

## Optionals/Spare Parts

Description	Part number	
SmartyCam 3 GP Module	<b>XS3GPFHD00</b>	
Bullet Cams	Part number	
Bullet cam 67°	<b>XS3B06700</b>	
Bullet cam 84°	<b>XS3B08400</b>	
Bullet cam 120°	<b>XS3B12000</b>	
Bullet Cam Cables	Part number	
0.5 m	<b>V02584190</b>	
1 m	<b>V02584180</b>	
1.5 m	<b>V02584170</b>	
2 m	<b>V02566980</b>	
2.5 m	<b>V02584220</b>	
3 m	<b>V02584160</b>	
4 m	<b>V02584070</b>	



# SmartyCam 3 GP

On-board camera

## Kits, accessories & spare parts

### Optionals/Spare Parts

CAN ECU cables	Part number	
CAN ECU cable 2 m	<b>V02566930</b>	
CAN ECU cable 4 m	<b>V02566940</b>	
CAN ECU cable + Jack 2 m	<b>V02584140</b>	
CAN ECU cable + Jack 4 m	<b>V02584150</b>	
Jack cable 1 m	<b>V02584040</b>	

CAN Exp. cables	Part number	
CAN Expansion cable 2 m	<b>V02554820</b>	
CAN Expansion cable 4 m	<b>V02554830</b>	

Other cables	Part number	
USB 2.0 Type A cable	<b>X90TMPC101010</b>	

Battery charger with AC adapter	Part number	
AC Adapter: substitute □ with <b>E</b> for Europe, <b>G</b> for UK, <b>U</b> for USA, <b>A</b> for Australia	<b>X06A12VBM□</b>	







# SmartyCam 3 GP

On-board camera

## Kits, accessories & spare parts

### Optionals/Spare Parts

Bracket kits for record unit	Part number	
<b>Roll-bar kit</b> In the box: handlebar bracket, 90 mm arm, clamp base with ball, mounting bracket, locknuts, washers and screws	<b>X90KSGPRB</b>	
<b>U-bolt kit</b> In the box: U-bolt, 90 mm arm, clamp base with ball, mounting bracket, locknuts, washers and screws	<b>X90KSGPTP</b>	
<b>Suction cup</b> In the box: suction cup, 90 mm arm, clamp base with ball, mounting bracket, locknuts, washers and screws	<b>X90KSGPVS</b>	
Bracket kits for bullet cams	Part number	
<b>Roll-bar kit</b> In the box: handlebar bracket, 60 mm arm, ball head, bullet-cam bracket	<b>X90KSBLRB</b>	
<b>U-bolt kit</b> In the box: U-bolt, 60 mm arm, ball head, bullet-cam bracket	<b>X90KSBLTP</b>	
<b>Suction cup</b> In the box: suction cup, 60 mm arm, ball head, bullet-cam bracket	<b>X90KSBLV0</b>	